

## Contents

- P1 Introduction
- P2 Parts List
- P3 Sub assembly Help
- P4 Bearing detail
- P5-7 Making top 1 - 3
- P8 - 10 Photo details
- P11 - Counter Balance box

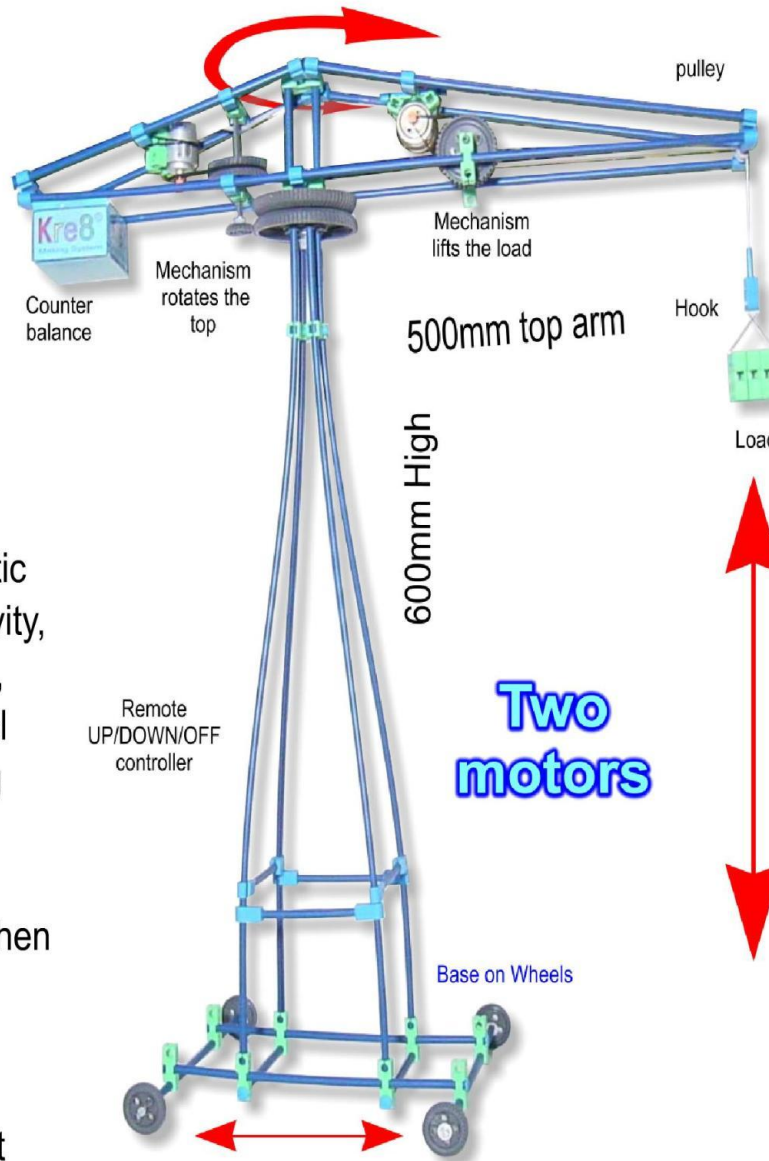
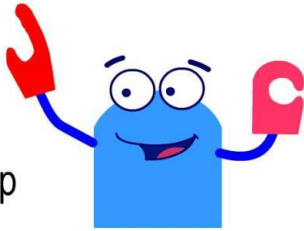

## Activity ideas

*Try different load types*

*PS - Use some of the spare parts or things laying around to lift up and move about .*

*You could have a competition for two people to see how fast and accurate you can move a load .*

*Will be more fun with two people and even more if two or models are used at the same time.*

*To make it fair some rules may need to be used.*

**Note** - To make assembly easier - Smooth and round the ends with **abrasive paper** and **twist rods** as they are pushed into the connectors.

**The manual controller** operates the two motors independently  
One motor lifts the load and the second swings the boom around.

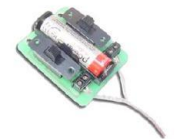

## You will learn & achieve

**Knowledge** - Energy- potential, stored, kinetic energy, linear to rotary motion, centre of gravity, balance, friction, measuring, reducing friction, mass and speed. gearing, structures, Control using switches, wiring up motors, ratios using pulleys and mechanisms.

### Making

Assembly and constructions skills - testing then adjusting to get best results. Possible competition. Refining and solving technical hitches.

**Designing** - Practical adjustments to get best results. Customisation after initial testing.

Trim all sharp edges after cutting

### Easy Assembly

The rods are easier to insert into the connectors if twisted as they are pushed into place. Younger students should 'round off' and smooth the tube and rod ends using the abrasive paper.

## Tools

### Snips

Use to cut Kre8 connector hinges, plastic sheet, light blue tubing etc

Note - Scissors are not very satisfactory as they do not have serrated blades.



### Emery Cloth

Use fine 'emery cloth' or other 'abrasive paper' to round and smooth the slit rod or blue tube ends to make assembly easier.

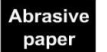

### Pencil and Rule

Use to mark lengths of blue tube or slit rods before cutting. Can also be used on plastic sheet before shapes are cut out.



## TIP

Punch hole in red square

OR

If you do not have a punch you can fold in half and cut a notch out

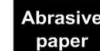

Two of these needed

## Making a Pulley

bevelled side  
uppermost

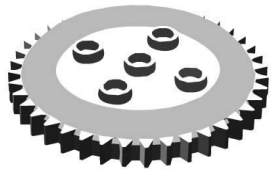

using 40 mm dia gear

bevelled sides  
face each other

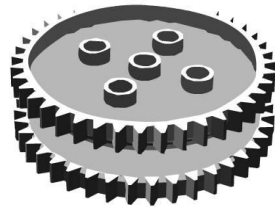

push  
insert

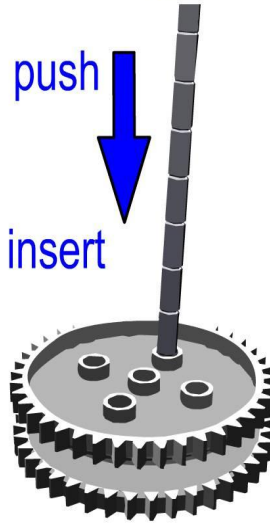

push  
snap  
off

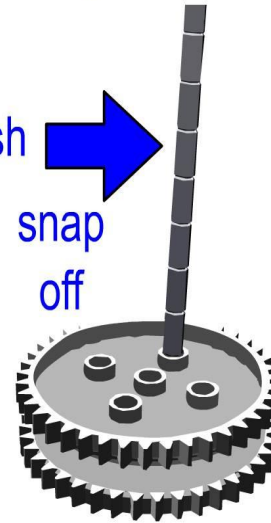

repeat for two or more  
opposite holes  
(NOT the centre hole)

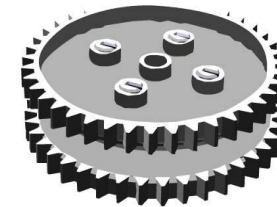

Two of these needed

## Making a Motor Assembly

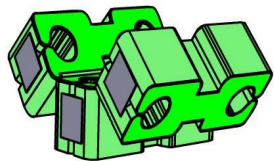

bend sides  
upwards

cut light blue tube  
60mm long

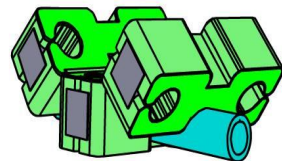

twist and push in  
central hole

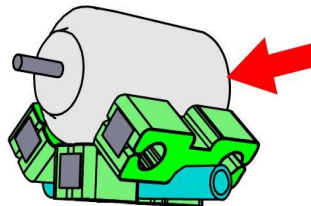

lay motor  
in place

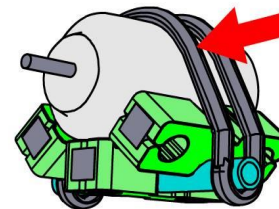

Loop short rubber  
band over the top

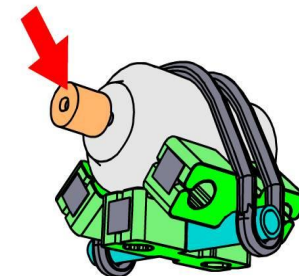

Add short  
orange tube

# 4

## Kre8® Tower Crane - Making Top 1

Also see photo details on pages 8, 9 & 10

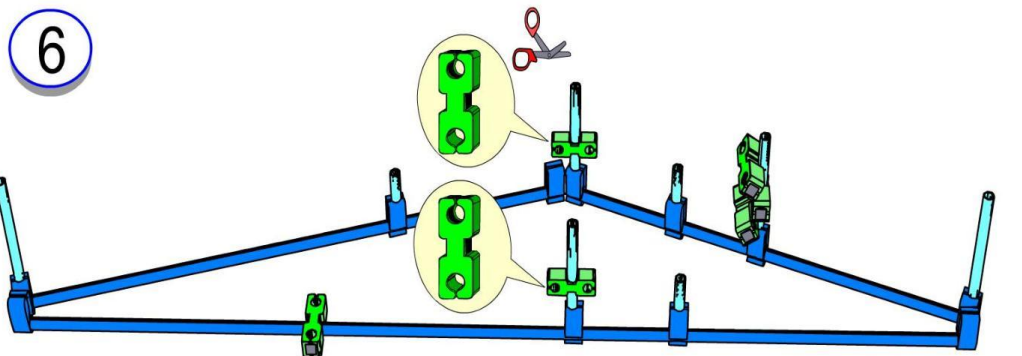
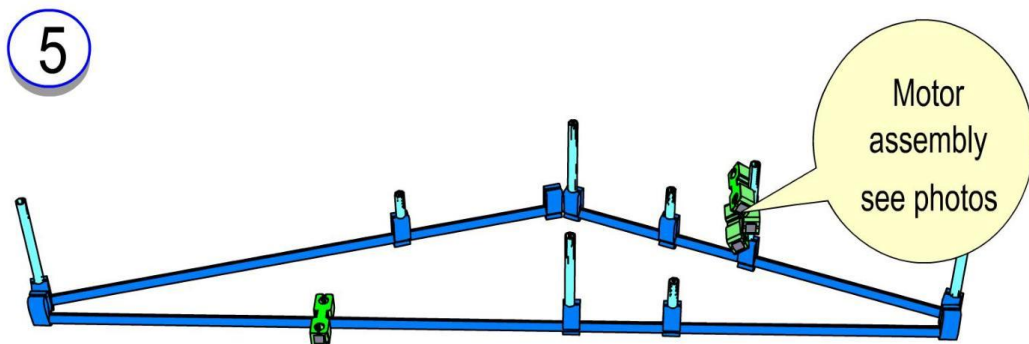
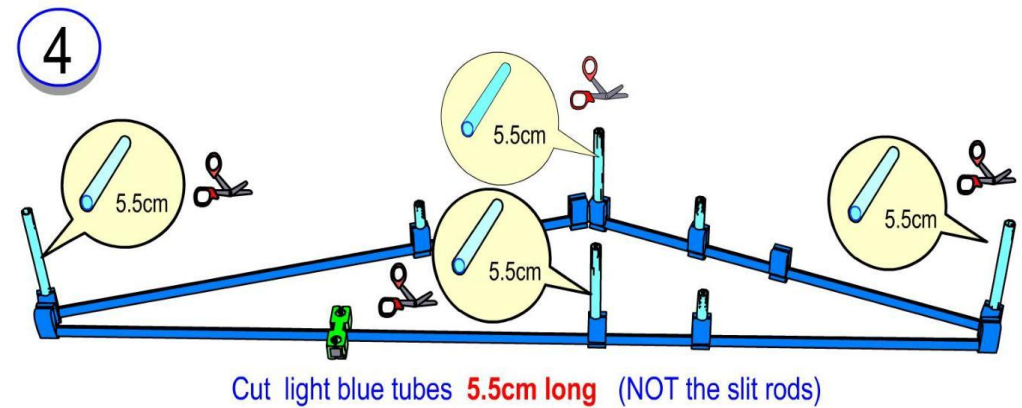
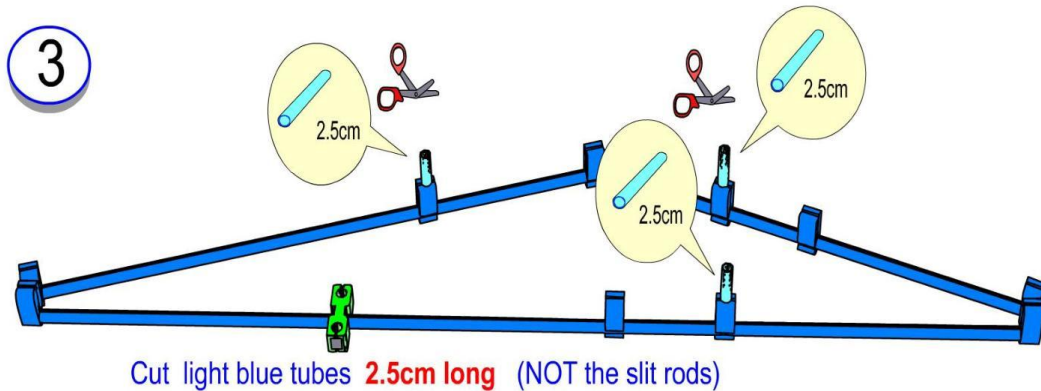
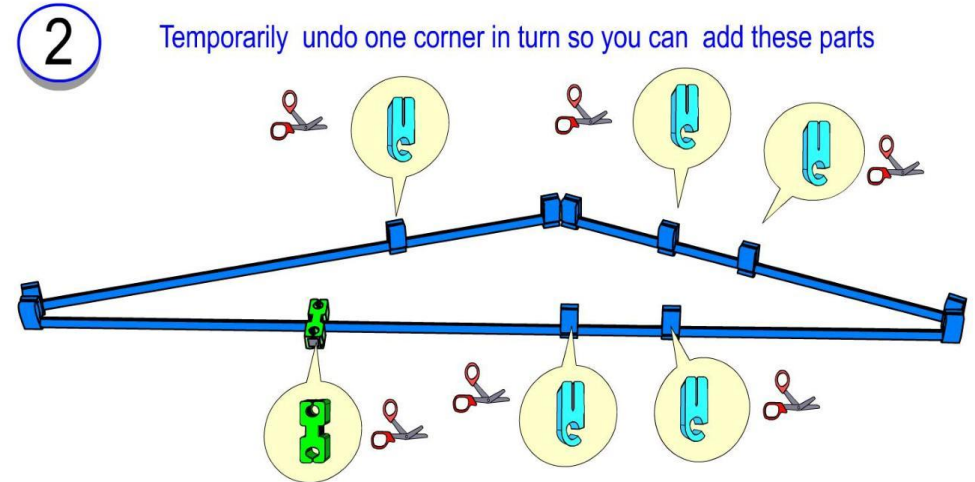
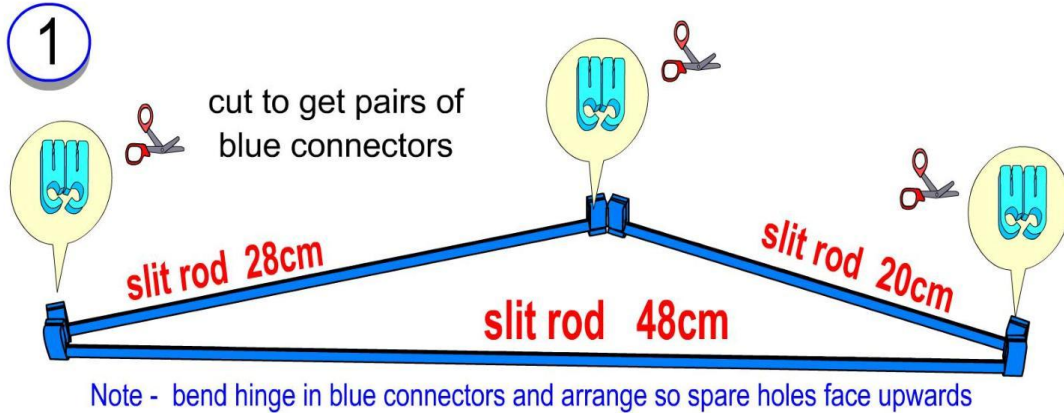

5

# Kre8® Tower Crane - Making Top- 2

Also see photo details on pages 8, 9 &10

7

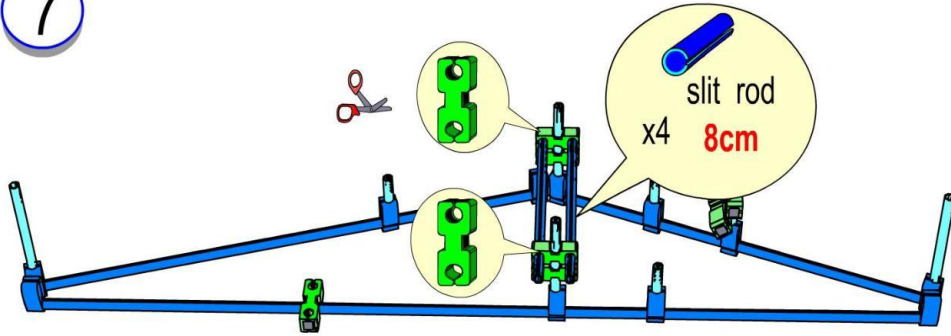

8

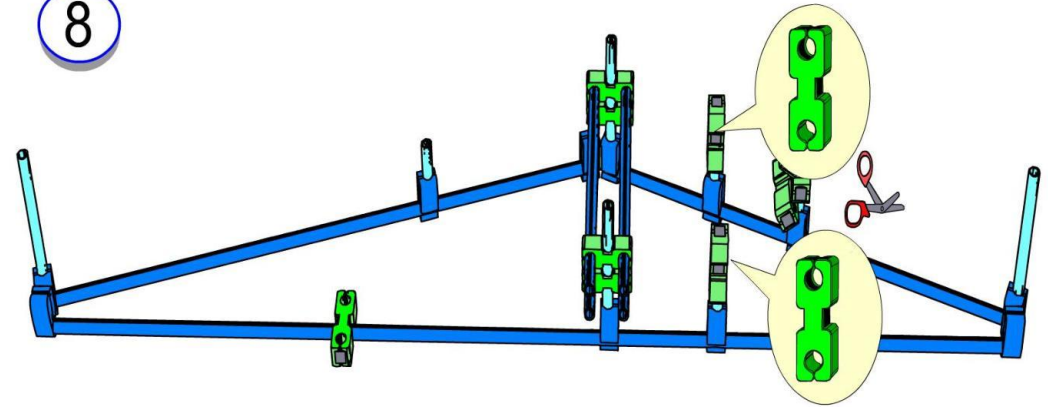

9

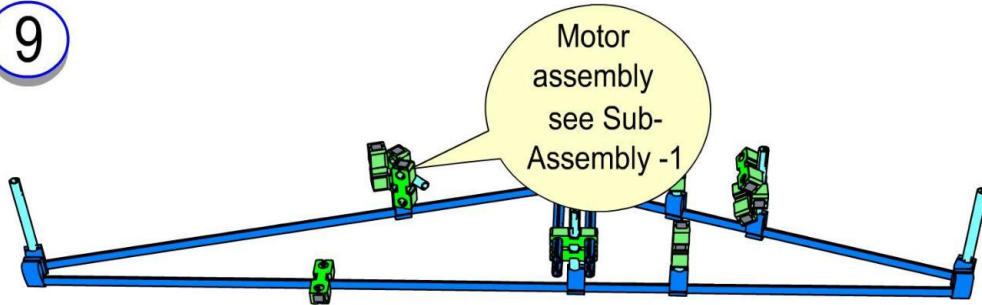

10

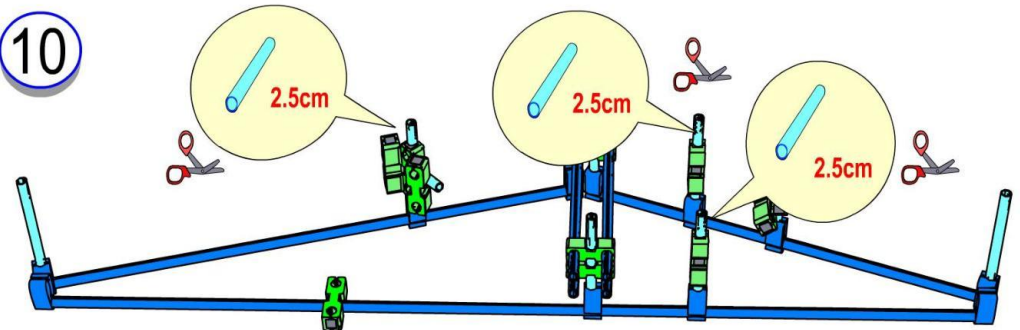

11

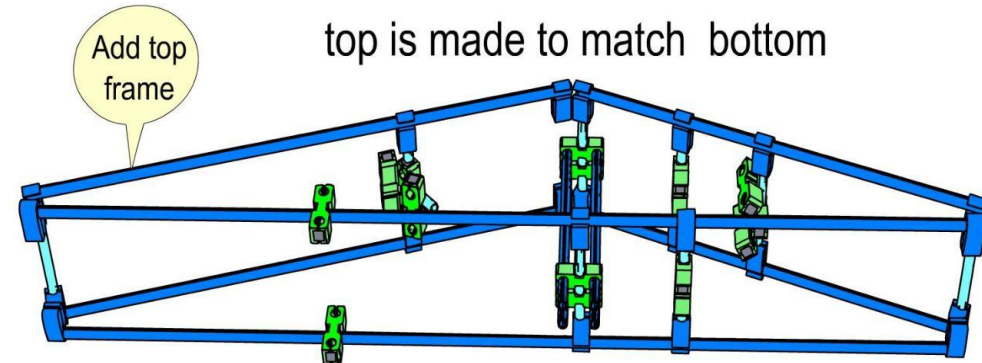

12

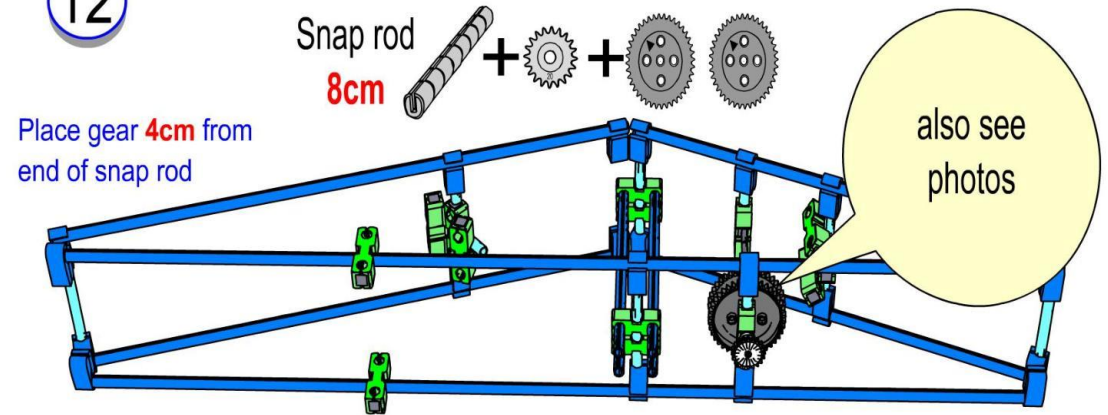

6

# Kre8® Tower Crane - Making Top 3

Visit [www.kre8.com](http://www.kre8.com) for zoomable pages, movies etc

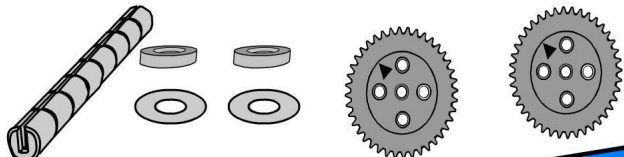
- 13 Snap rod  
8cm long
- 
- Place pulley from one end of snap rod

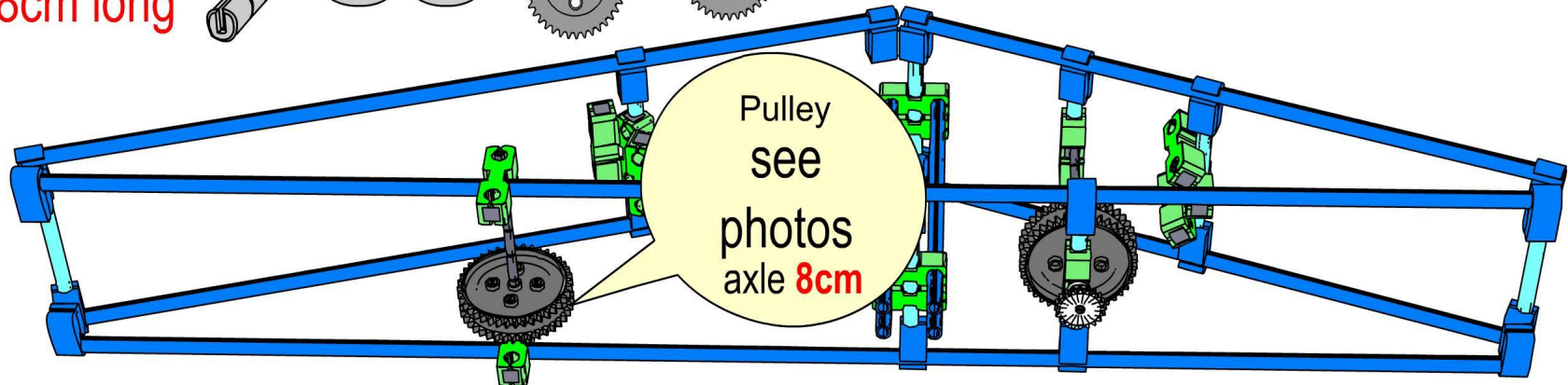

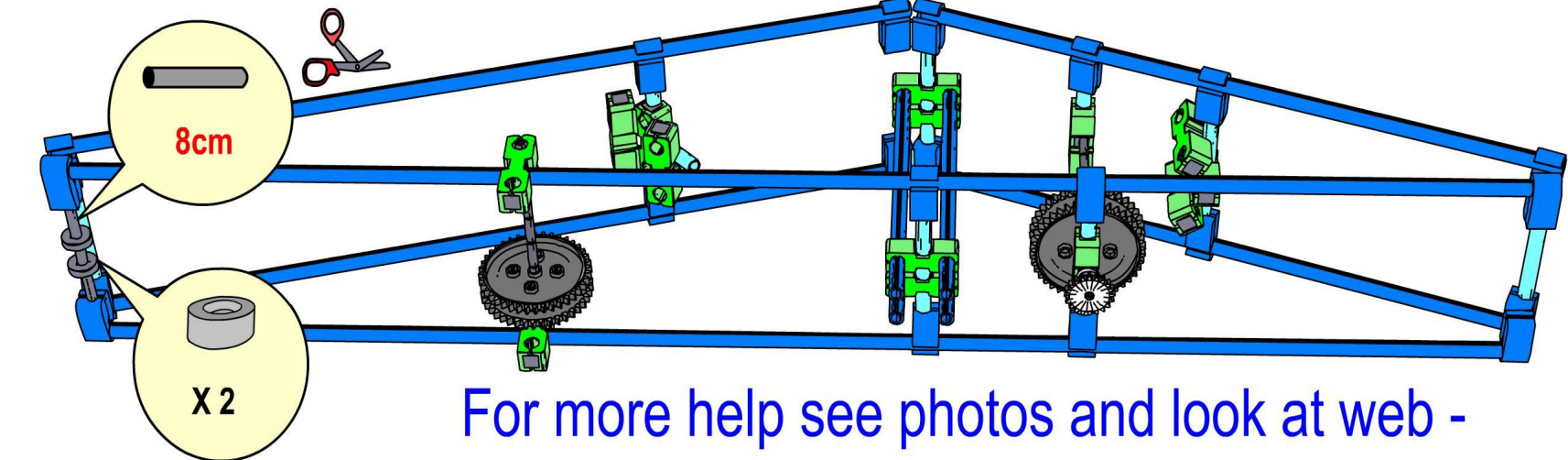
- 14
- 
- 8cm
- X2

For more help see photos and look at web -  
can zoom into photos as needed

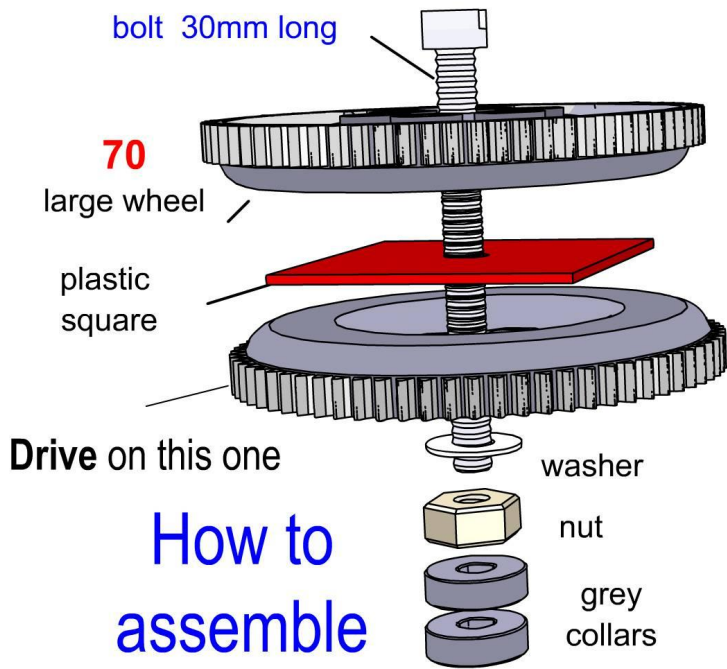

**How to assemble**

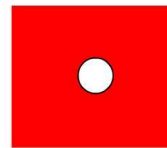
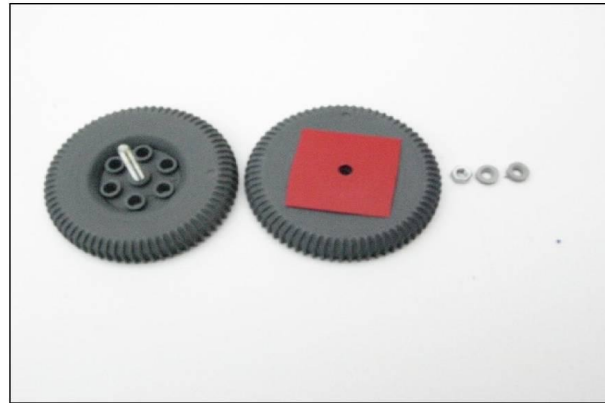

Hole needed in centre



Part assembled

The bearing shown above joins the top and bottom of the crane. To ensure the blue rods (added later) do not get in the way as the top turns a red plastic piece of plastic is added in the centre as shown. A 4 mm hole is needed in the centre of red piece it can either be drilled or fold the plastic in half and cut a notch out. (if too difficult card sheet could be used

NOTE Adding the blue rods is difficult if you do not first smooth and round the slit rods ends. Use abrasive paper for this.

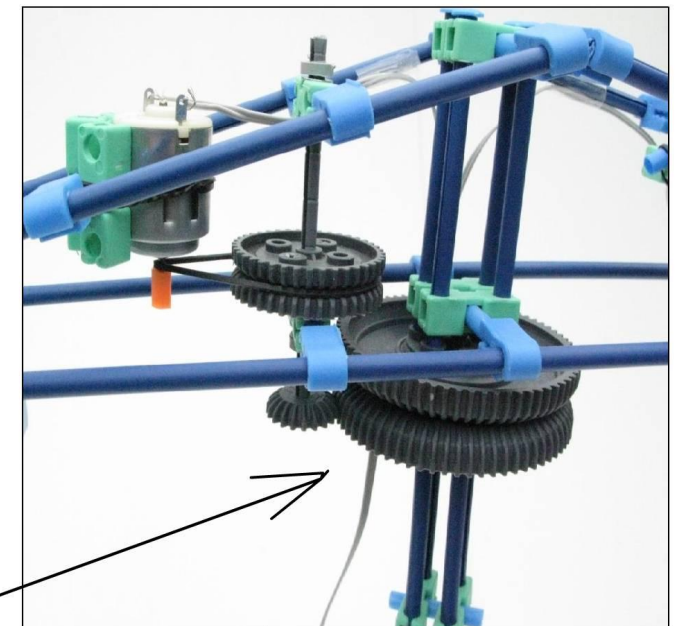

In use

# 8

## Kre8® Tower Crane - Base Unit

Assemble base shape with wheels added by pushing 3mm dia bolts into the ends of the slit rods as shown

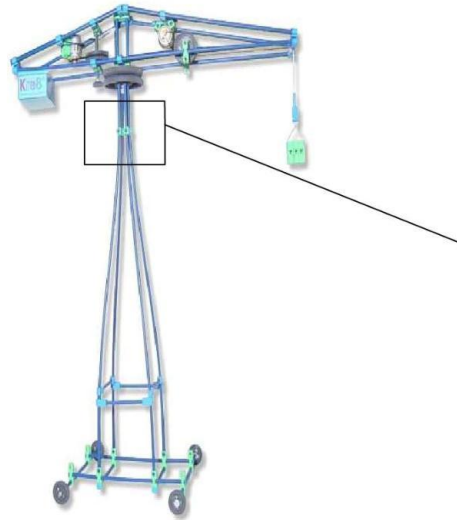
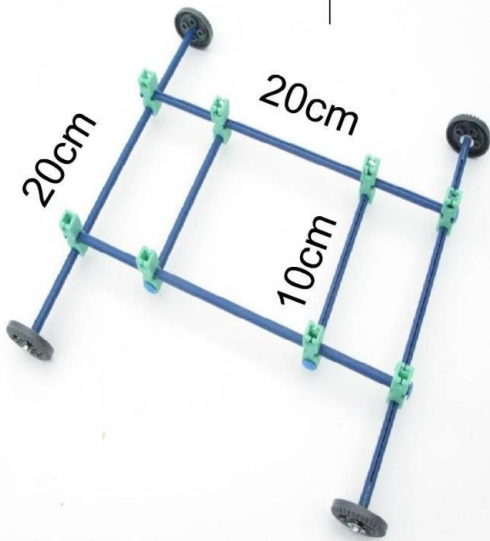
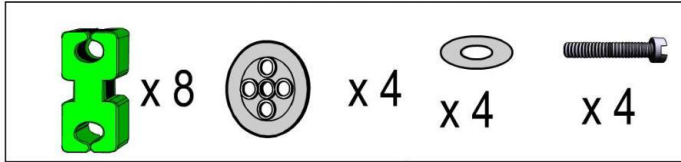

Adding tall part

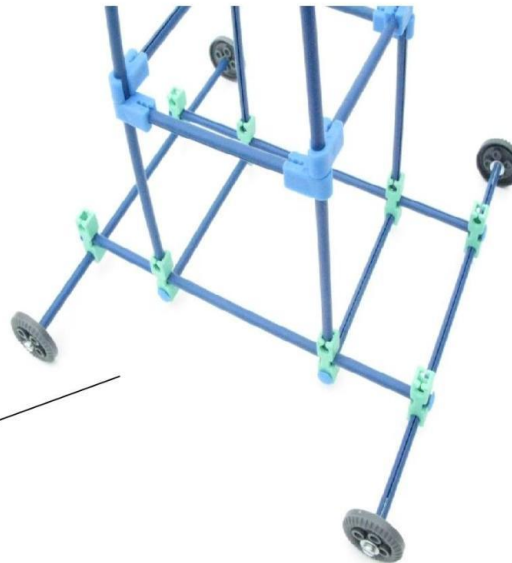

Adding tower part - using the long slit rods

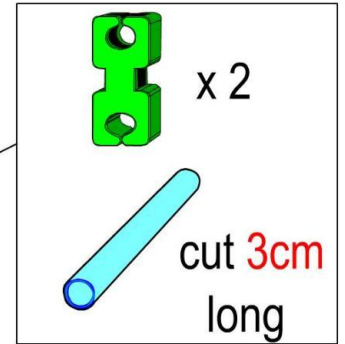
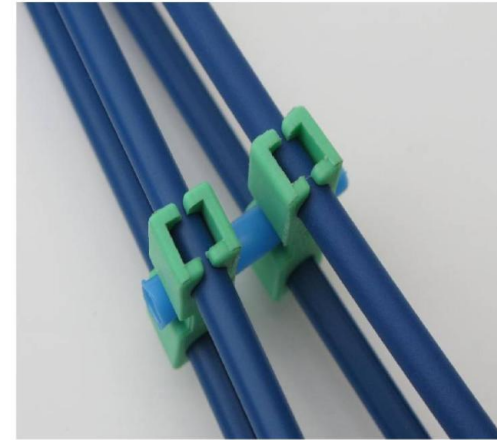

Adding controller

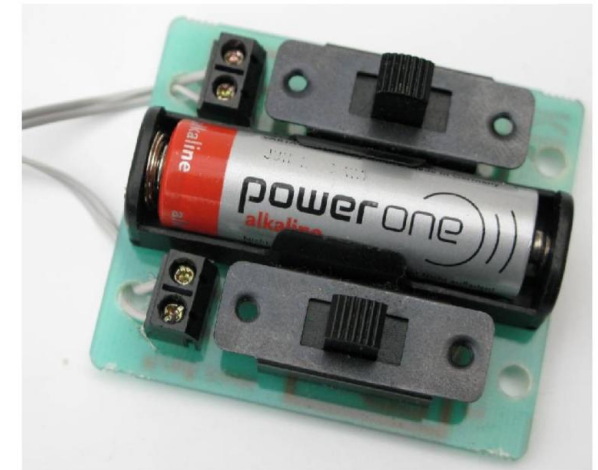

Add the long ribbon cable as shown then join to motors on crane

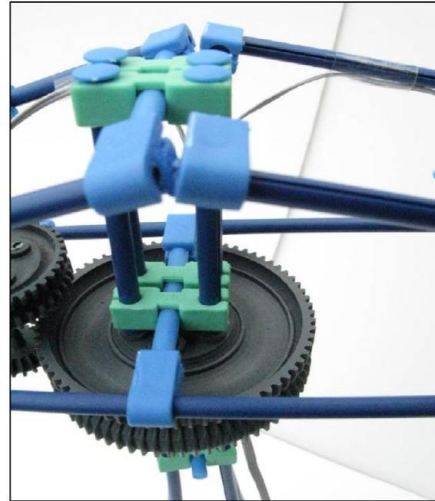

Top detail

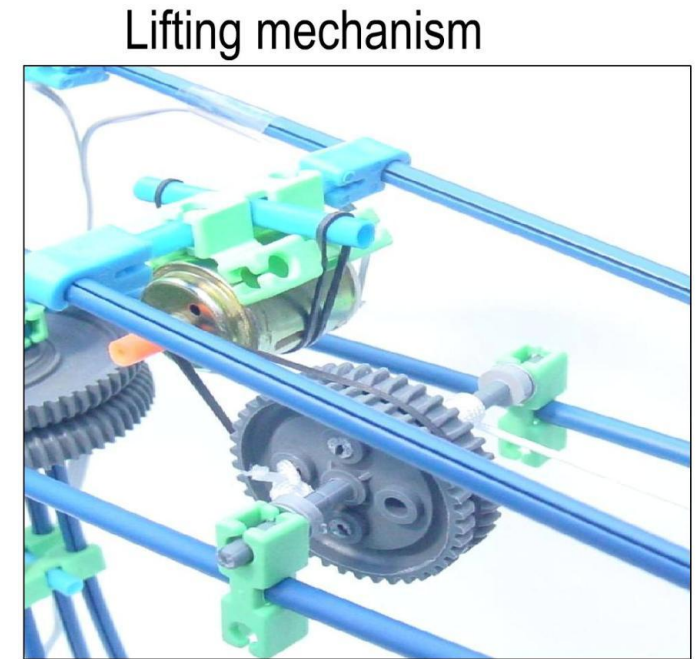

Lifting mechanism

Lifting mechanism- Rear view

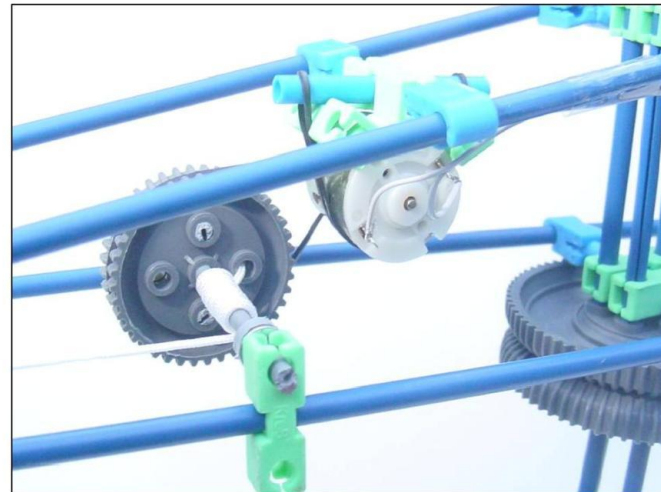

showing cord added

Front pulley detail

4.5cm



+

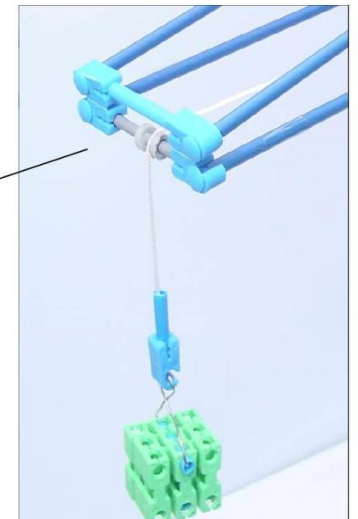



Adding the counter weight box  
Use clear tape  
(can push into slits in rods)

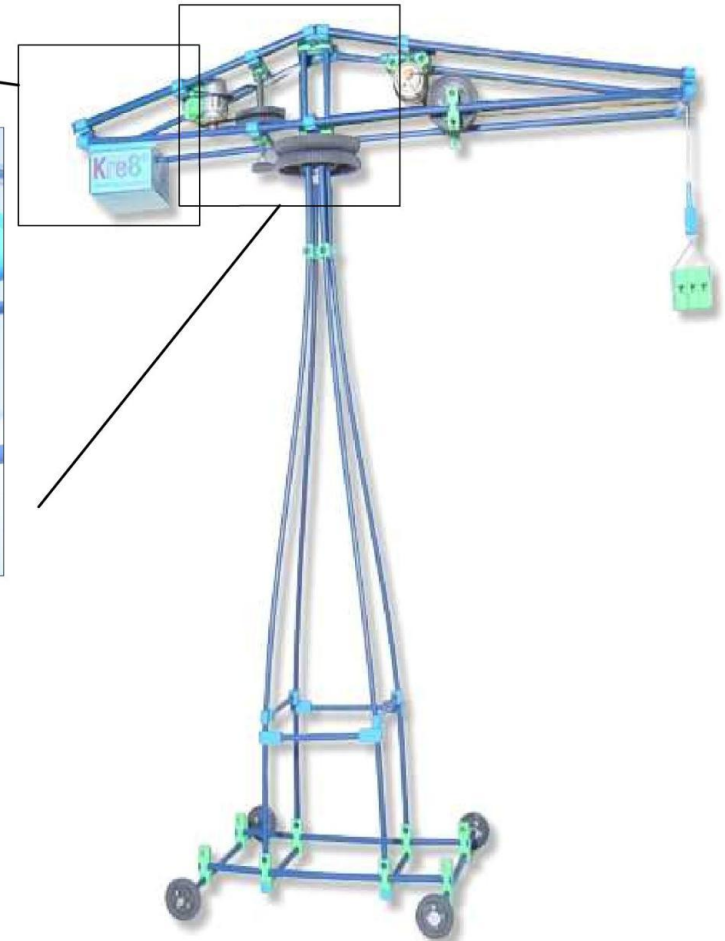

Top turning mechanism

Top turning mechanism (different view)

11

# Kre8® Tower Crane Counter Balance Box

If supplied as a kit this will be supplied plastic laminated

In use - a small counter weight can be added in box

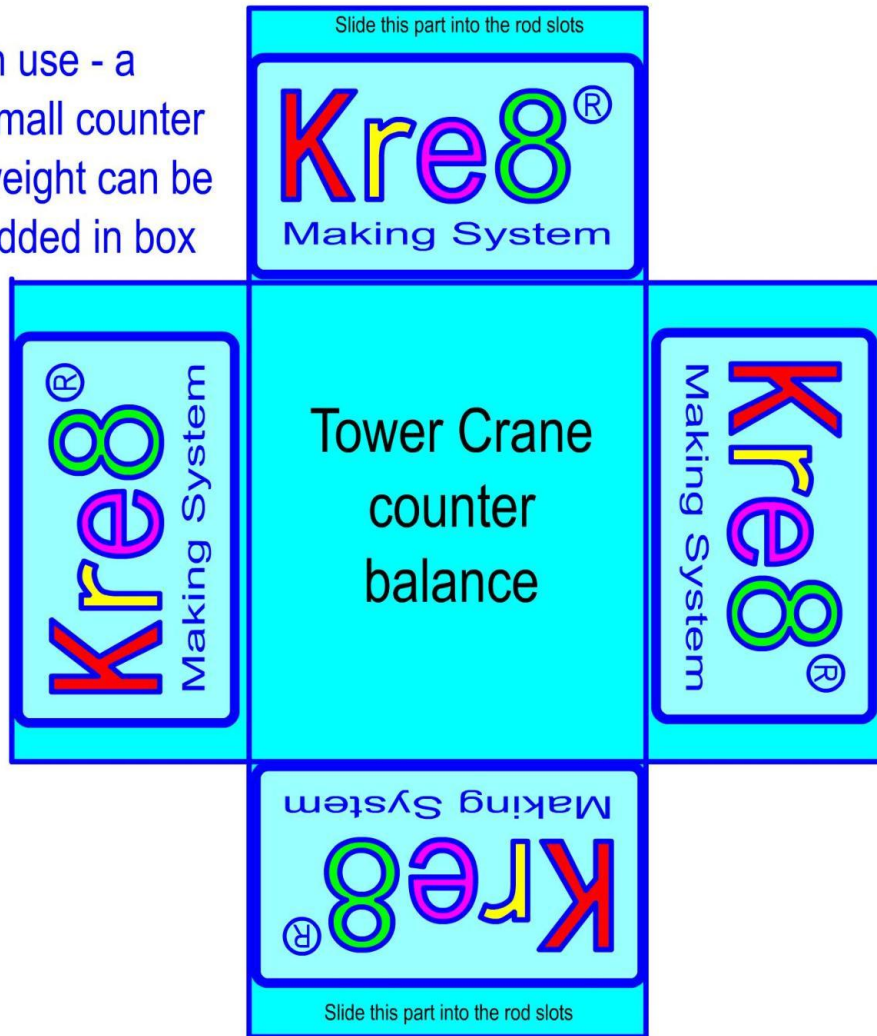

To make - 1) cut out the shape above then 2) score the bend lines then 3) using clear tape join the corners

# Kre8® Tower Crane Counter Balance Box

If supplied as a kit this will be supplied plastic laminated

In use - a small counter weight can be added in box

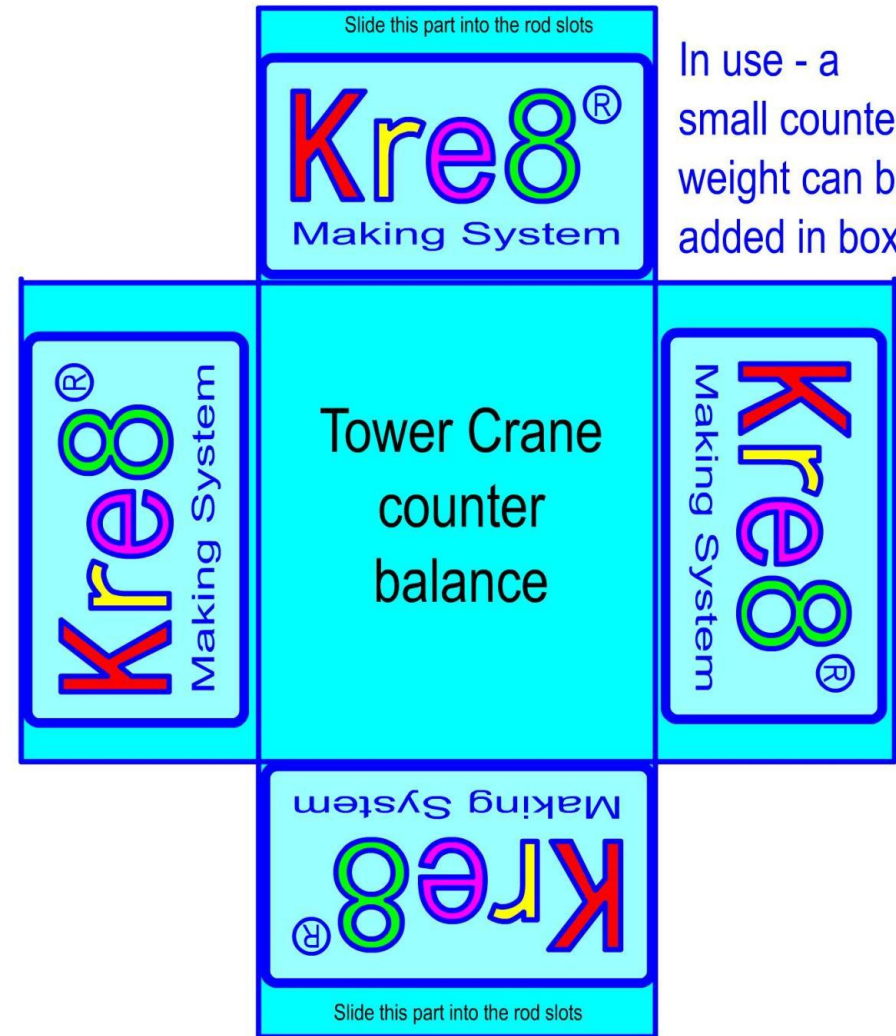

To make - 1) cut out the shape above then 2) score the bend lines then 3) using clear tape join the corners