

Contents

Parts List

Making 1/2

Making 2/2

Decoration sheet

Teacher Notes

for 8 years plus
topics mechanism
using axles,
reducing friction,
using construction
kits with shell
structures as well
as designing
making and testing.

This Kre8 low cost Ezi-Car is quick and easy to make as shown or customize as wanted using card.



Keywords

Movement, wheels, axle rotate, balance, friction, loose fit, tight fit, assembly, chassis, vehicles.

Extra Challenges

- Get it to steer straight. (by adjust the clips on the long blue rods)
- Make a test slope to see which car rolls down best and goes the furthest.
- Add a sail to your car and blow it along.
- Make a 'train' by linking a few cars together.

Typical size

16cm long x 9cm wide

Illustrated below are the parts used to make the example model



1 x decoration sheet

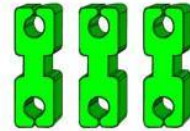

1 x multiblock connector

Cut up to make three single blocks as shown

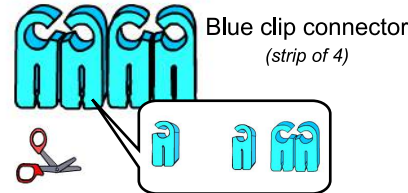

Can be cut up and used as single, double or triple as well

4 x strips of clip connectors

Cut up all and use as 'single blocks' as shown

Safety - Remove sharp edges

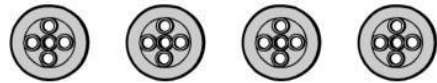

4 x 28mm dia wheels Push onto the 4mm axles.

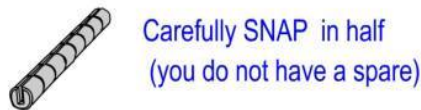

Carefully SNAP in half (you do not have a spare)

1 x 4mm grey snap axle
Snap in half to make 2 x 8cm long.

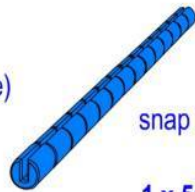

snap into 4 x 5cm pieces
1 x 5mm dia. snap rod

Abrasive paper

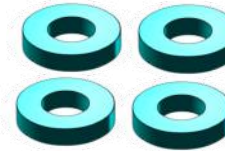
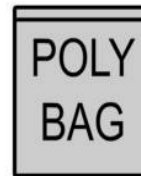

4 x blue collars

Abrasive paper

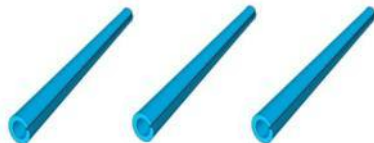

3 x slit rods 12cm long

For instructions see Ezi-Car at www.kre8.com

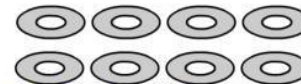

8 x 4mm hole washers
Can be used on axles next to the wheels to reduce friction and make wheels turn better.

Tools

Snips

Use to cut Kre8 connector hinges, plastic sheet, light blue tubing etc
Note - Scissors are not very satisfactory as they do not have serrated blades.



Scissors

Use to cut the card top

Emery Cloth

Use fine 'emery cloth' or other 'abrasive paper' to round and smooth the slit rod or blue tube ends to make assembly easier.

Pencil and Rule

Use to mark lengths of blue tube or slit rods before cutting. Can also be used on plastic sheet before shapes are cut out.
NOTE - You can use the rule at the bottom of the pages of making instructions.



Roll of clear tape



SAFETY

Keep hands away from sharp edge when drilling
Stick glue and clear tape to fix decoration part. and clear tape to hold card shape to long slit rod

Kre8 Tube Cutter

Not needed for this kit but is useful if the slit rods need to be cut by 'scoring' than 'snapping off' the rods to length



Easy Assembly

To make assembly easier round the end of the rods using the abrasive paper provided.

Decoration - Either use the decoration sheet provided or add your own design using card shapes you have designed. The decorated parts push into the the connectors or the slit rods. If too loose add a piece of clear tape to hold in place

Kre8[®] Ezi-Car - Making 1

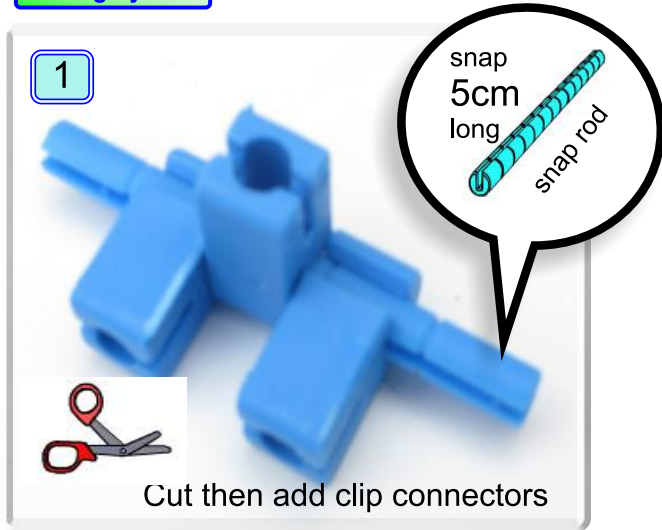

Tip - To make assembly easier use the abrasive paper to round the ends of the rods

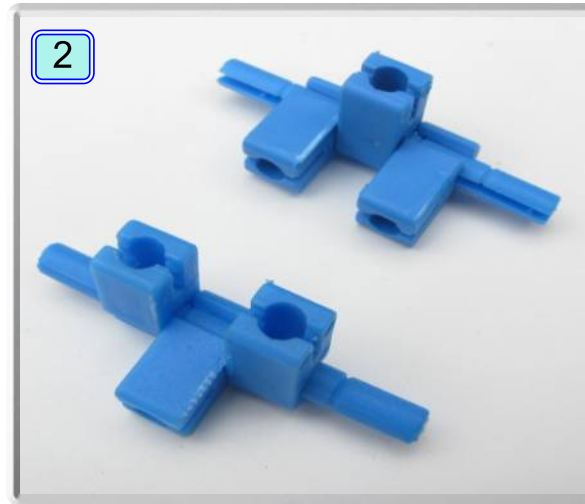

Make 2nd copy

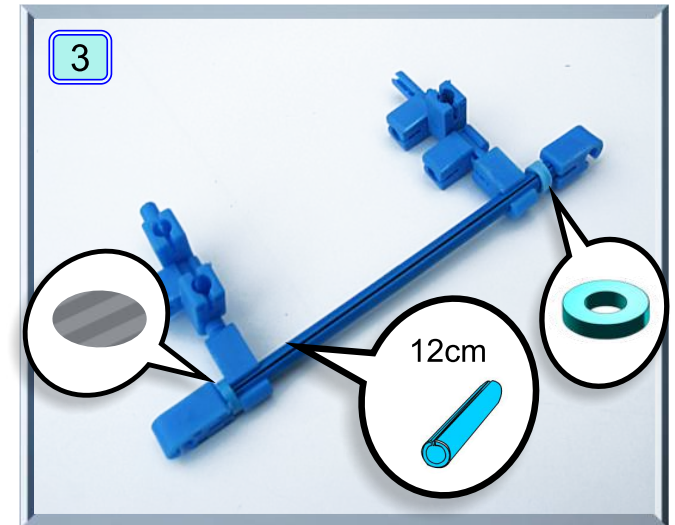

Add first side using clip connectors

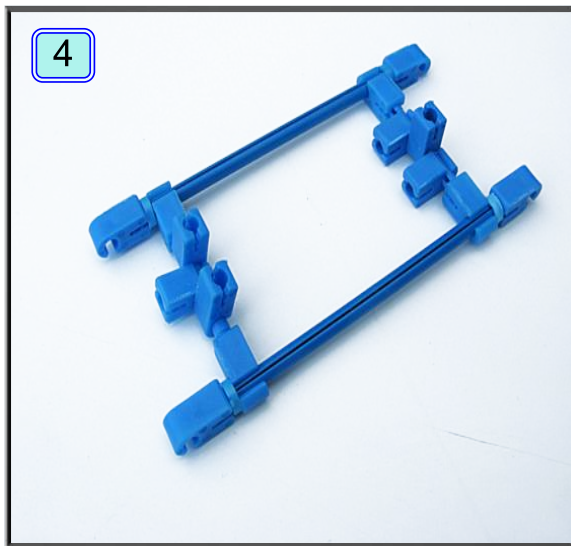

Add second side

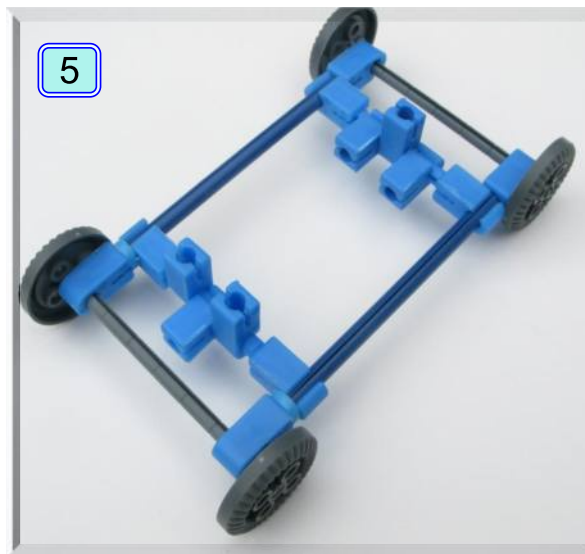

Add axles and wheels



Add front decoration

Kre8[®] Ezi-Car - Making 2

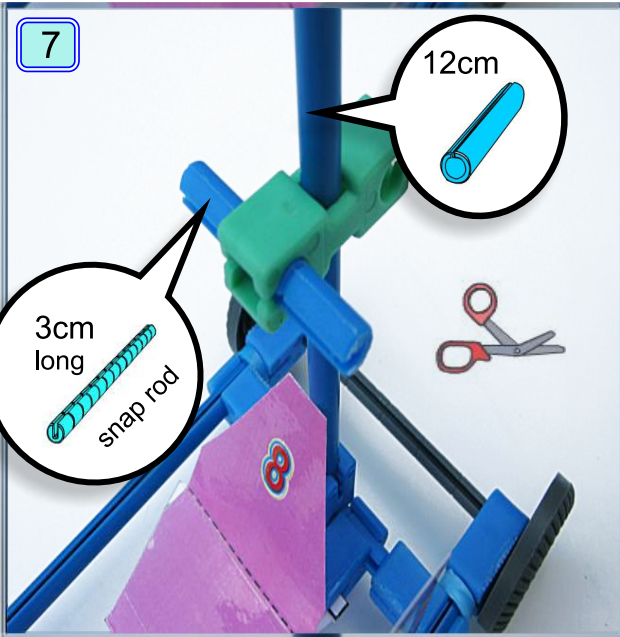

Add flag pole 12cm long then slide add one green unit connector (cut) on it and 3cm long snap rod placed in it.

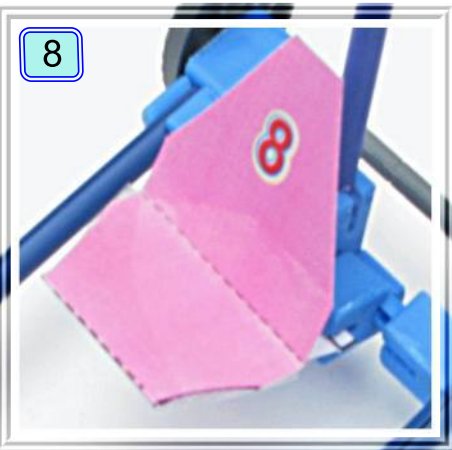

Add seat



Finish off by adjusting to get best effect

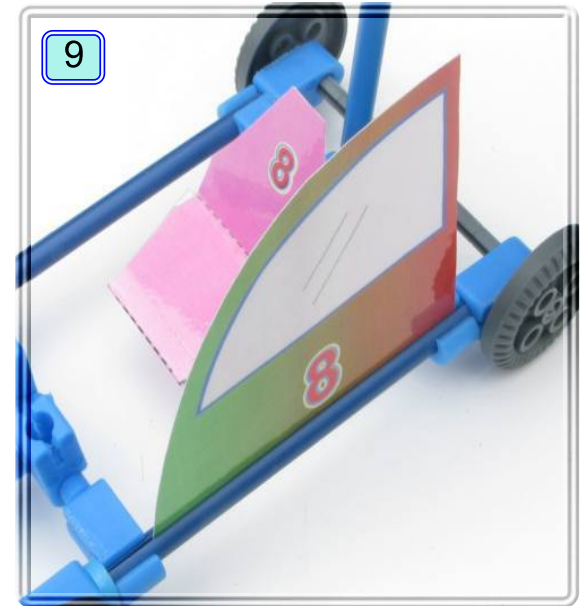

Add sides by placing in the slit of the rod (then use clear tape to hold in place)



Add flag and aerfoil

Kre8[®] Ezi-Car - Decoration Sheet

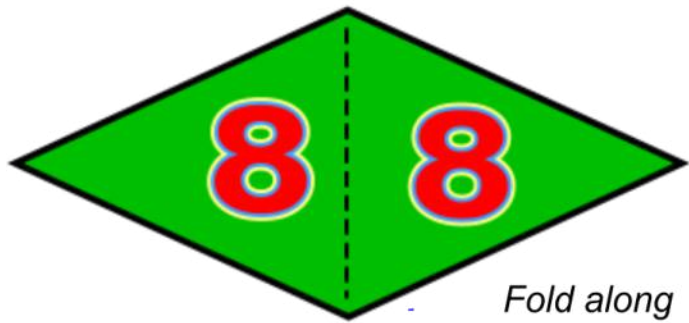

Flag

Fold along dotted line then slide it the slit rod. then tape ends together.

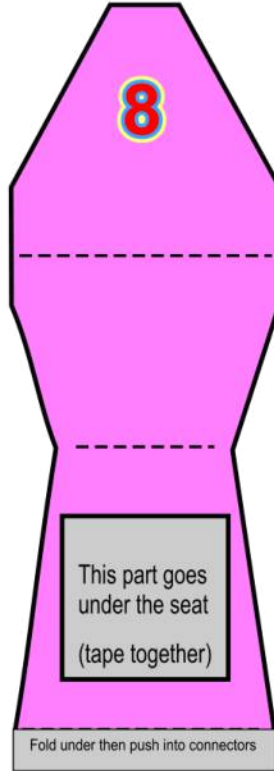

Seat (optional)

To make parts

- *Score the 8 dotted lines (using a ball point pen)
- *Cut out parts
- *Fold along dotted lines
- *Insert in plastic connectors or slit rod slot (sides)

Note - Tape can be added to thicken card instead of folding the card over.

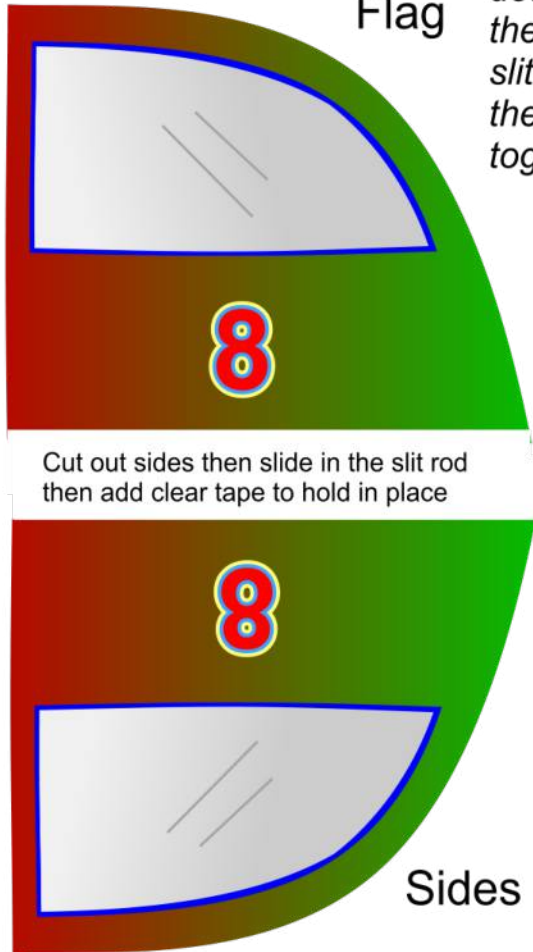

Sides



Front

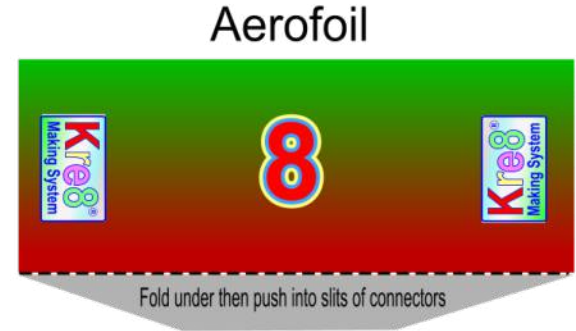

Aerofoil



Body Cover