

## Contents

- P1 Content (this page)
- P2 Parts List
- P3 Making
- P4 Making
- P5 Making
- P6 Photos
- P7 Alternative blades
- Movie link - see web

## Activities

See how bright you can make the LED glow using wind provided naturally or by using a large electric fan like that shown

- 1) Assemble model then
  - 2) Experiment with the following variables
    - a) wind speed
    - b) number of blades
    - c) angle of blades
    - d) shape of blades.
- Includes gearing to increase motor speed

## Key Words

Energy, energy conversion, force, balance, pitch, gearing up stability, testing, solar motor, efficiency, power, voltage and current

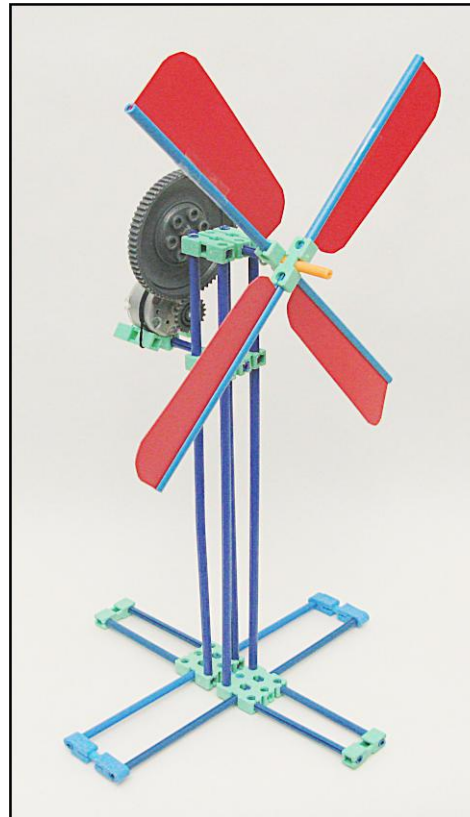

### Features

*400mm high - renewable energy source, adjustable parts for experimentation, geared up solar motor, Can power a few LEDs and can be tested without wind by spinning the axle using orange finger axle. (when blades removed)*

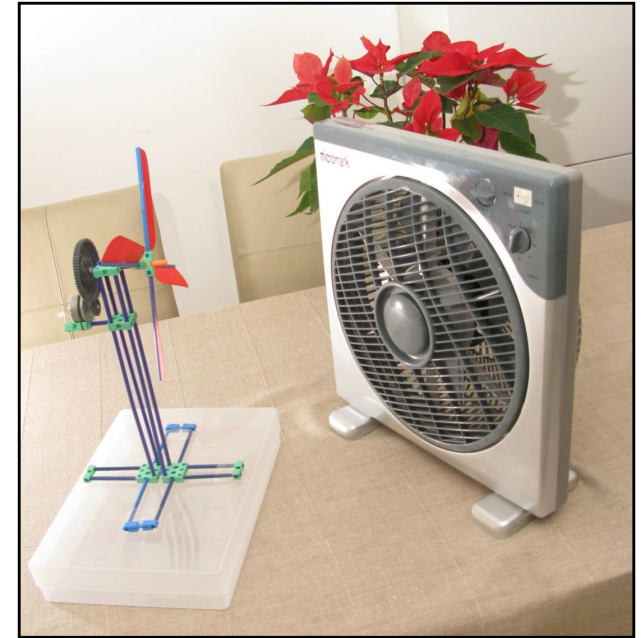

*Use a fan like this when no wind, tape model to a large box to stop it being blown over.*

## Safety

**Stability** - Hold the model down to a base with tape to stop it falling over. Use **goggles** when testing in case blades fly out. To ensure blades are tight in the green multi-blocks you may need to place clear tape on the rods. The plastic blades can also be fixed using clear tape. Test in a safe area. Do a balance manual spin test first to ensure it will spins well.

## PARTS LIST

- slit rods
- 4x 280mm
- 2 x 200mm
- 5 x 80mm
- 4 x 120mm
- 1 X 50mm
- Other
- 1x light blue tube
- 2 x clip connectors
- 7 x multi-blocks
- 2 x 4 to 2mm converter
- 1 x 2mm axle
- 1 x 3mm washer
- 1 x orange bendy tube
- 1 x rubber band large
- 1 x 70mm gear
- 1 x 20mm gear
- 1 x sheet of sails
- 1 x LED
- 1 x abrasive paper
- 1 x 1m yellow wire



Blue clip connector  
(strip of 4)

2 x Clip connectors

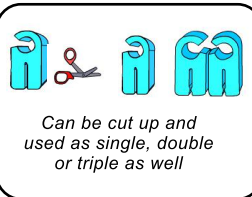

Can be cut up and used as single, double or triple as well

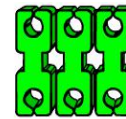

Green multiblock connector  
(strip of 3)

7 x Multi-blocks



Can be cut up and used as single or double as well



Instructions on the web  
[www.kre8.com](http://www.kre8.com)

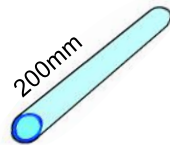

1 x 5mm light blue tube

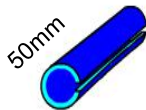

1 x 5mm slit rod

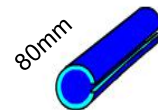

5 x 5mm slit rod



4 x 5mm slit rod

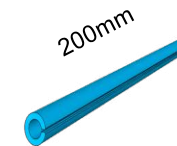

2 x 5mm slit rod

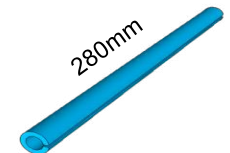

4 x 5mm slit rod

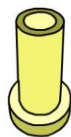

2 x 4 to 2mm converter  
(color can be white)



1 x 2mm dia. axle

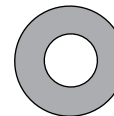

1 x 3mm washer



1 x Bi-col LED (white)



Plastic strip for sails

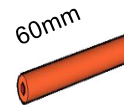

1 x Orange bendy tube 5mm dia.

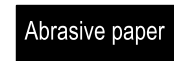

Abrasive paper

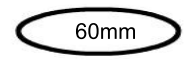

1 x rubber band



1 x 70mm gear



1 x 20mm gear



1 x 1metre of wire

### Tools you are likely to use



Snips  
(recommended)

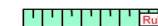

Rule (metric)



1 x Solar motor

**TO MAKE** ALL SIZES IN MM  
Use these 'step-by-step instructions' as a guide and adapt as you want.

- NOTES**
- 1) **ONLY** cut up connectors as needed
  - 2) Use metric ruler for measuring
  - 3) For **EASY** assembly -
    - a) Smooth and round the end of the rods with abrasive paper then
    - b) **Push and twist** the rods into place.

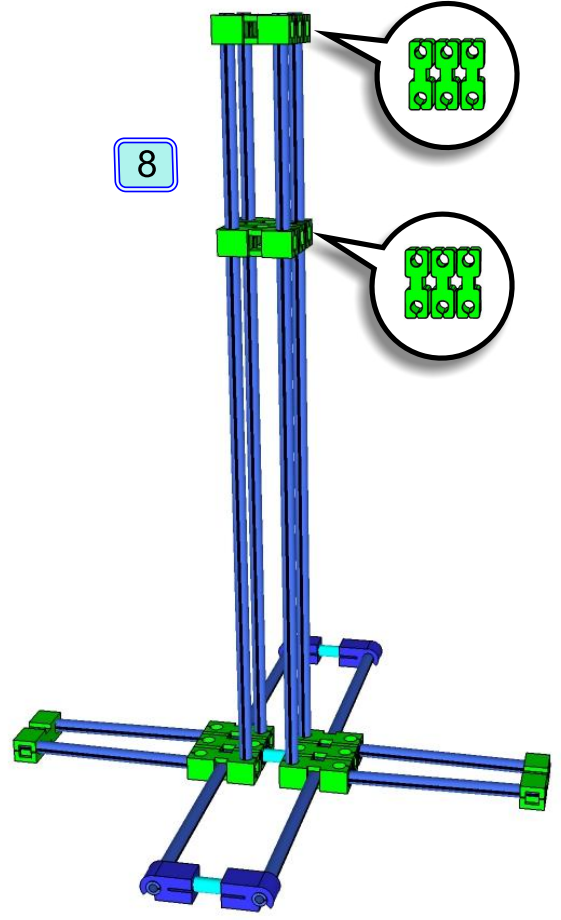
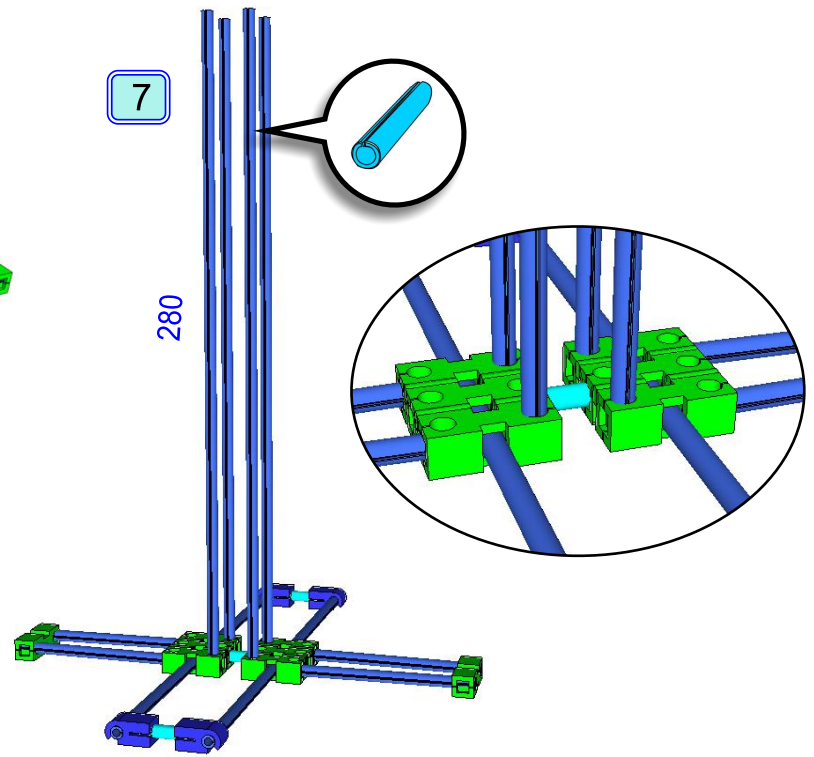
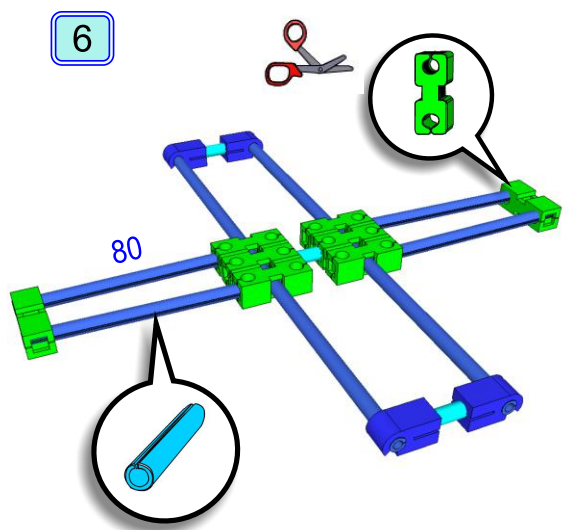
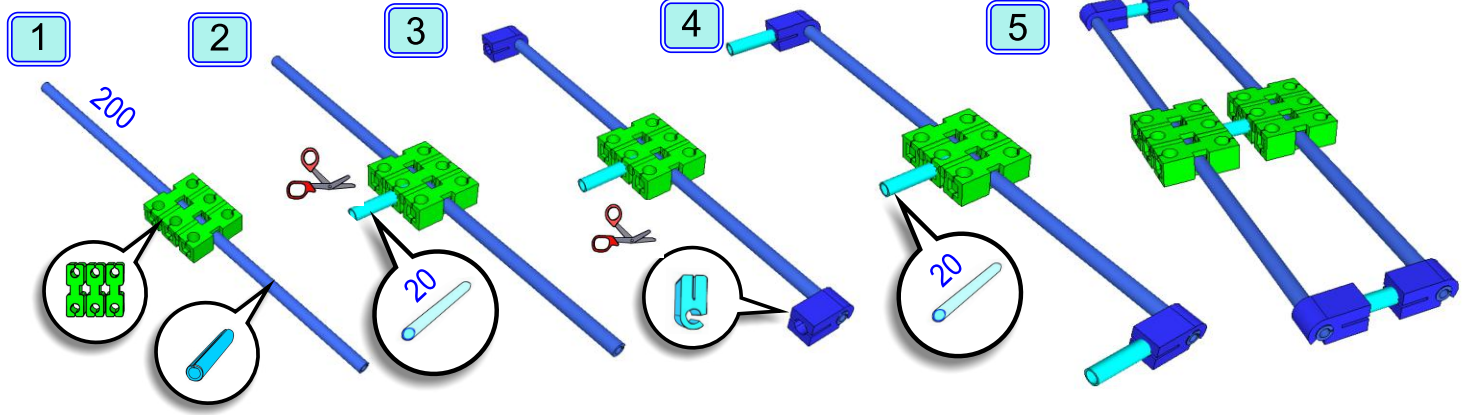

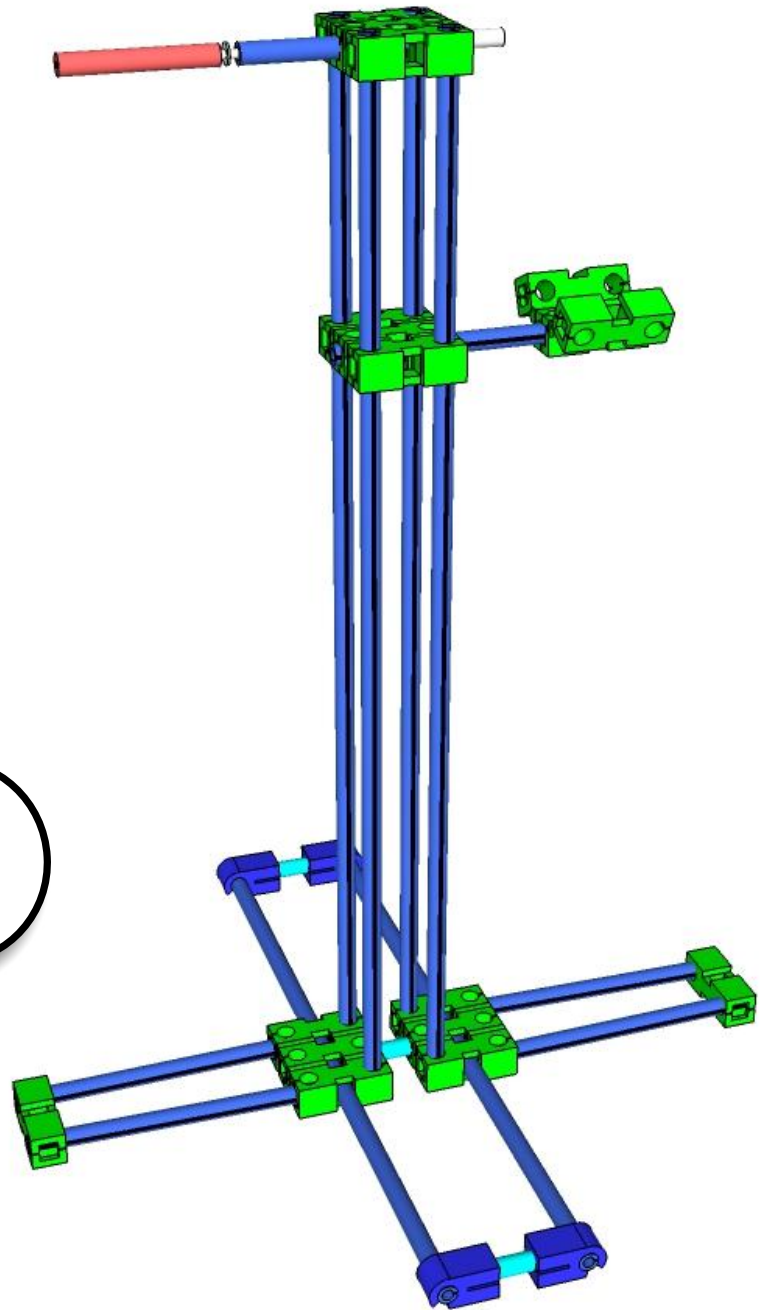
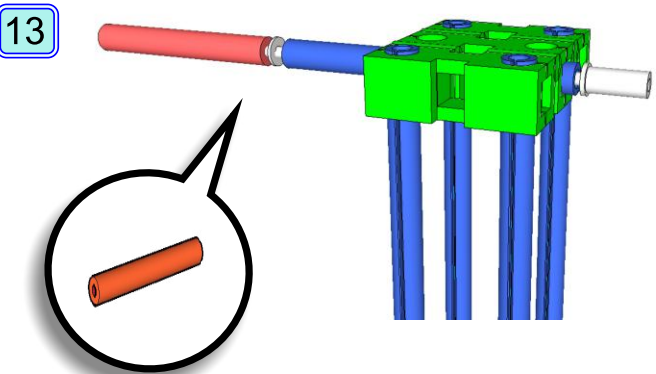
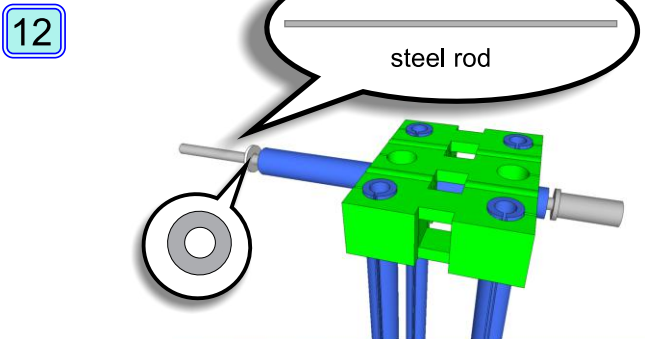
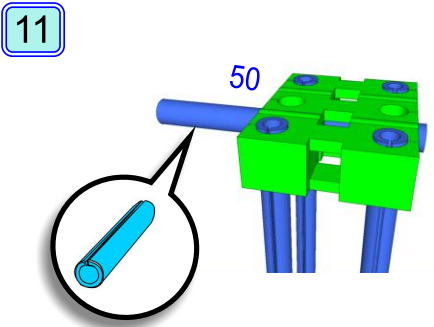
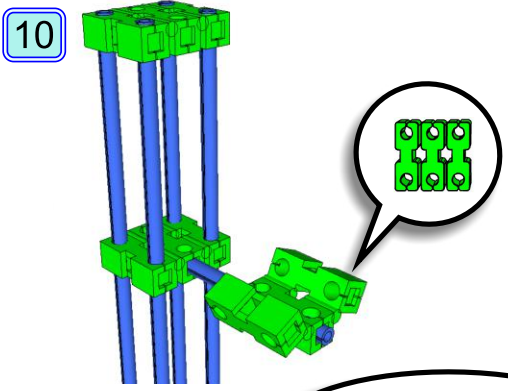
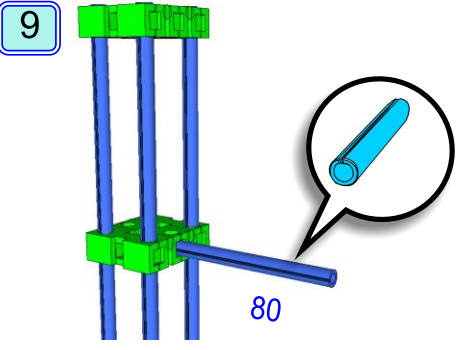

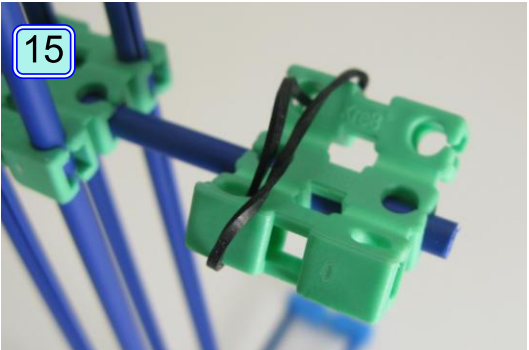

15

Add rubber band (using end holes)

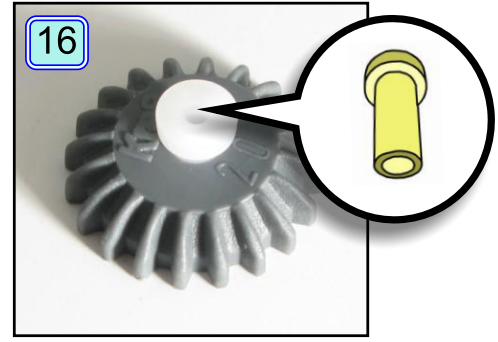

16

Slide converter in 20mm gear

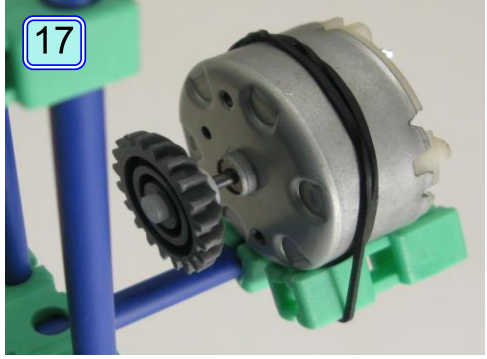

17

Slide motor under rubber band

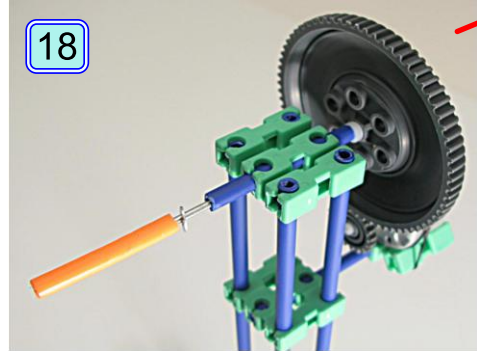

18

Add 70mm gear and adjust gears

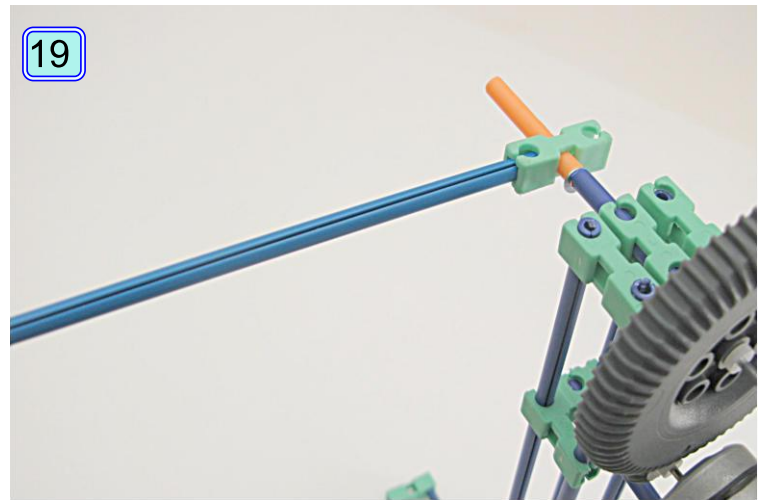

19

Add 120mm slit rod in single multi-block as shown



20

Cut out blade shapes and slide into slit rods

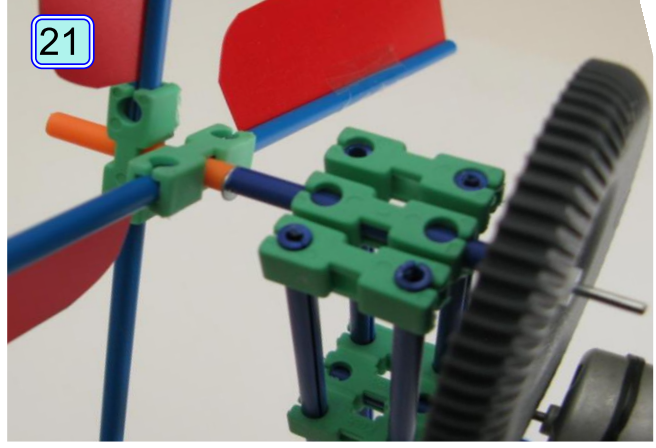

21

Add second pair of blades

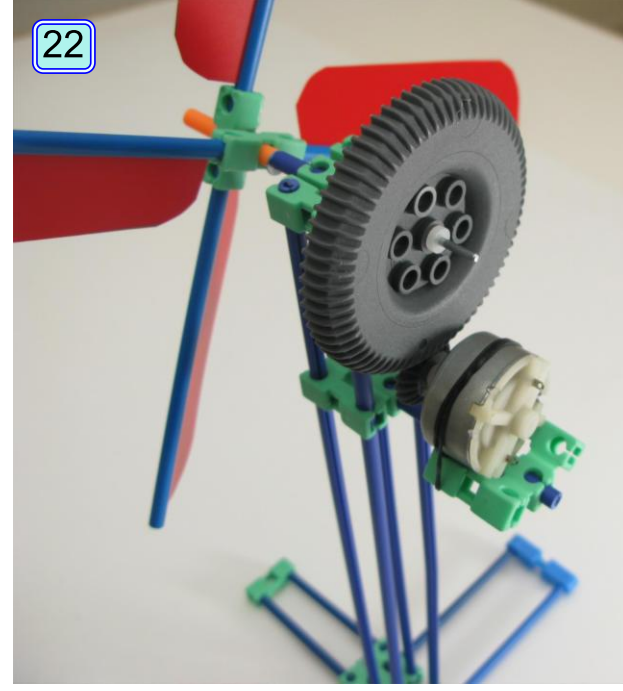

22

Test then add LED across the motor connections or use wires and add LED at the end

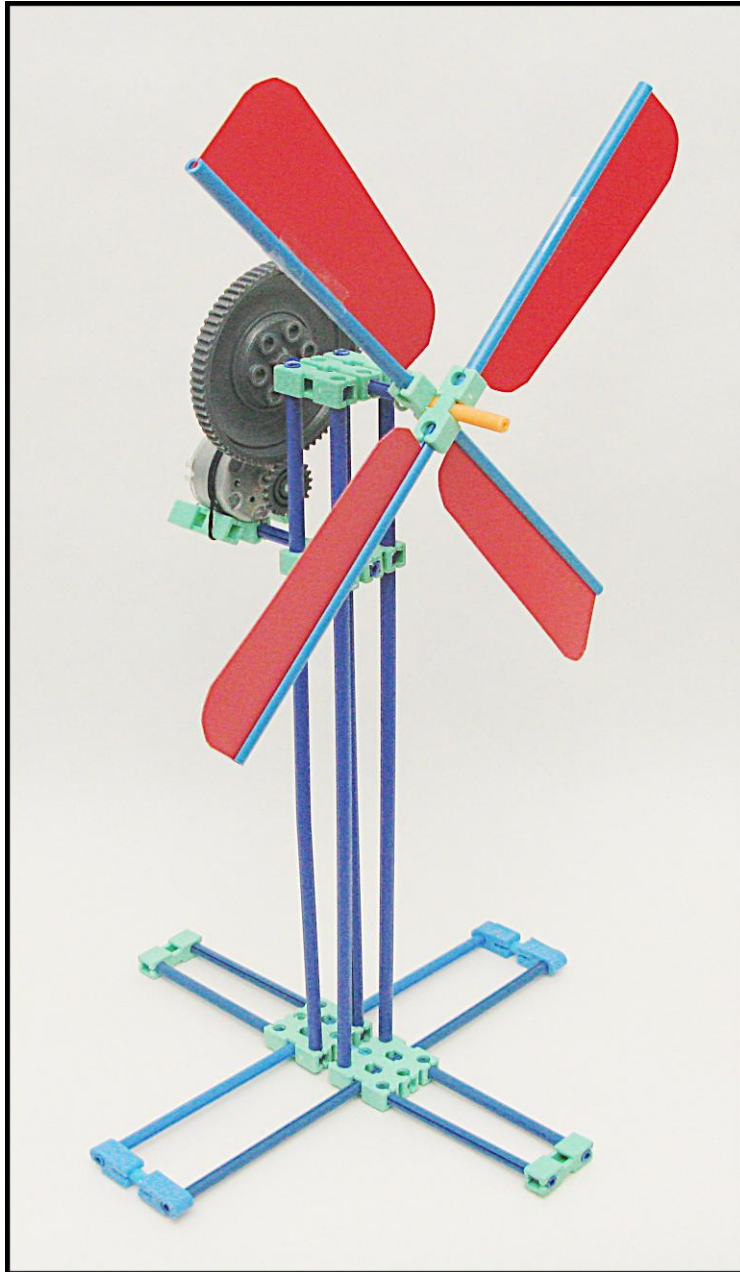

Assembled model



Model under test using the fan shown

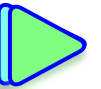
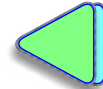

To make these blades print them out then plastic laminate to stiffen before cutting out

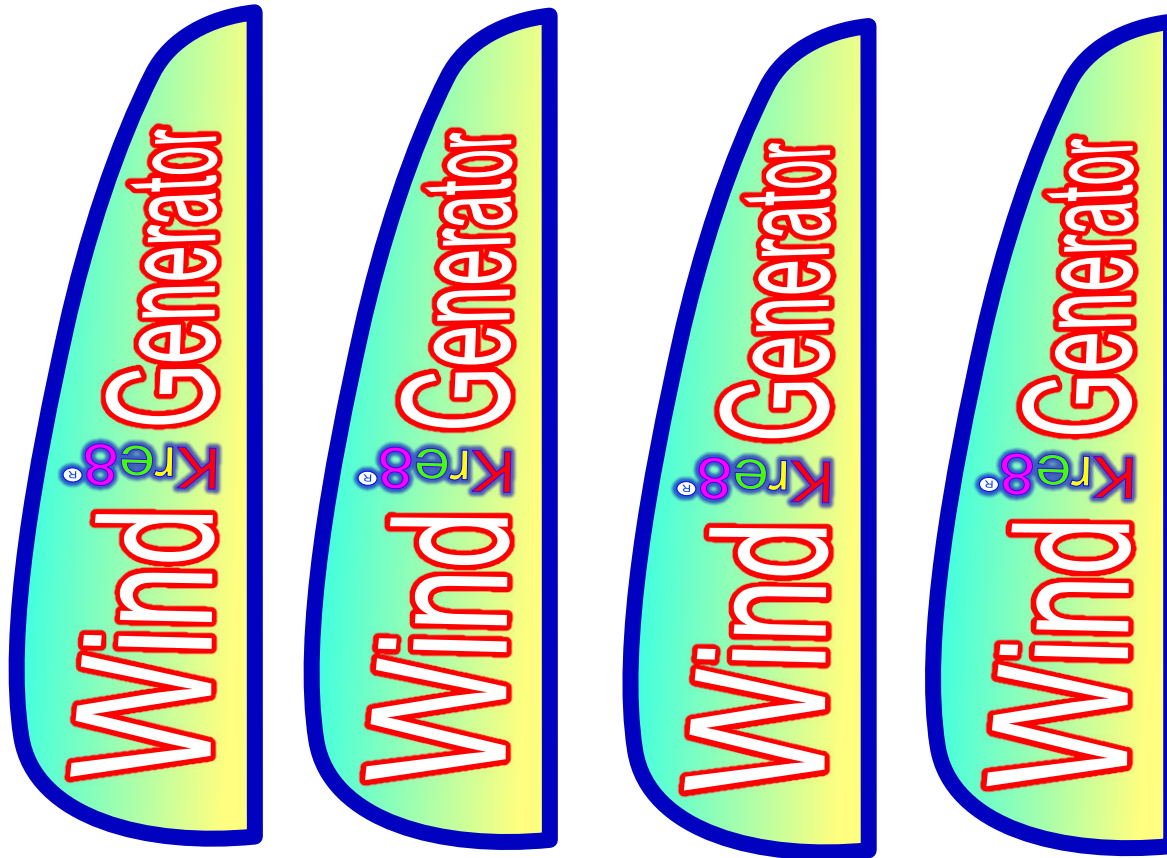

Add blades in slit rods on the model